

# LCG H9RM

## OSRAM OSTAR® Projection Cube

OSRAM OSTAR Projection Cube is a high flux LED for slim designs.

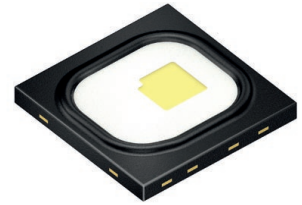

### Applications

- Projection Home LED & Laser
- Projection Mobile (LED & Laser)

### Features:

- Package: SMD epoxy package
- Chip technology: UX:3
- Typ. Radiation: 120° (Lambertian emitter)
- Color: Cx = 0.318, Cy = 0.642 acc. to CIE 1931 (● converted green)
- Corrosion Robustness Class: 3B
- ESD: 8 kV acc. to ANSI/ESDA/JEDEC JS-001 (HBM, Class 3B)

### Ordering Information

Type	Luminous Flux <sup>1)</sup> I <sub>F</sub> = 350 mA Φ <sub>v</sub>	Ordering Code
LCG H9RM-LXMX-1	112 ... 210 lm	Q65112A6831

## Maximum Ratings

Parameter	Symbol		Values
Operating Temperature	$T_{op}$	min. max.	-40 °C 100 °C
Storage Temperature	$T_{stg}$	min. max.	-40 °C 100 °C
Junction Temperature	$T_j$	max.	150 °C
Forward Current $T_s = 25\text{ °C}$	$I_F$	min. max.	100 mA 500 mA
Forward Current pulsed $D = 0.5 ; f = 120\text{ Hz} ; T_s = 25\text{ °C}$	$I_{F\ pulse}$	max.	1000 mA
ESD withstand voltage acc. to ANSI/ESDA/JEDEC JS-001 (HBM, Class 3B)	$V_{ESD}$		8 kV
Reverse current <sup>2)</sup>	$I_R$	max.	200 mA

## Characteristics

$I_F = 350 \text{ mA}$ ;  $T_s = 25 \text{ }^\circ\text{C}$

Parameter	Symbol		Values
Chromaticity Coordinate <sup>3)</sup> acc. to CIE 1931 within $\lambda = 500 \dots 600 \text{ nm}$	Cx	typ.	0.318
	Cy	typ.	0.642
Viewing angle at 50 % $I_v$	$2\phi$	typ.	$120 \text{ }^\circ$
Radiating surface	$A_{\text{color}}$	typ.	$0.72 \times 0.72 \text{ mm}^2$
Partial Flux acc. CIE 127:2007 <sup>4)</sup> $\Phi_{E/V 120^\circ} = x \cdot \Phi_{E/V 180^\circ}$	$\Phi_{E/V, 120^\circ}$	typ.	0.77
Forward Voltage <sup>5)</sup> $I_F = 350 \text{ mA}$	$V_F$	min.	2.70 V
		typ.	2.97 V
		max.	3.50 V
Reverse voltage (ESD device)	$V_{R\text{ESD}}$	min.	45 V
Reverse voltage <sup>2)</sup> $I_R = 20 \text{ mA}$	$V_R$	max.	1.2 V
Real thermal resistance junction/solderpoint <sup>4)</sup>	$R_{\text{thJS real}}$	typ.	20 K / W
		max.	25 K / W
Electrical thermal resistance junction/solderpoint <sup>6)</sup> with efficiency $\eta_e = 29 \text{ } \%$	$R_{\text{thJS elec.}}$	typ.	14 K / W
		max.	18 K / W

## Brightness Groups

Group	Luminous Flux <sup>1)</sup> $I_F = 350 \text{ mA}$ min. $\Phi_v$	Luminous Flux <sup>1)</sup> $I_F = 350 \text{ mA}$ max. $\Phi_v$	Luminous Intensity <sup>4)</sup> $I_F = 350 \text{ mA}$ typ. $I_v$
LX	112 lm	130 lm	41 cd
LY	130 lm	150 lm	47 cd
LZ	150 lm	180 lm	55 cd
MX	180 lm	210 lm	66 cd

## Chromaticity Coordinate Groups <sup>3)</sup>

within  $\lambda = 500 \dots 600 \text{ nm}$

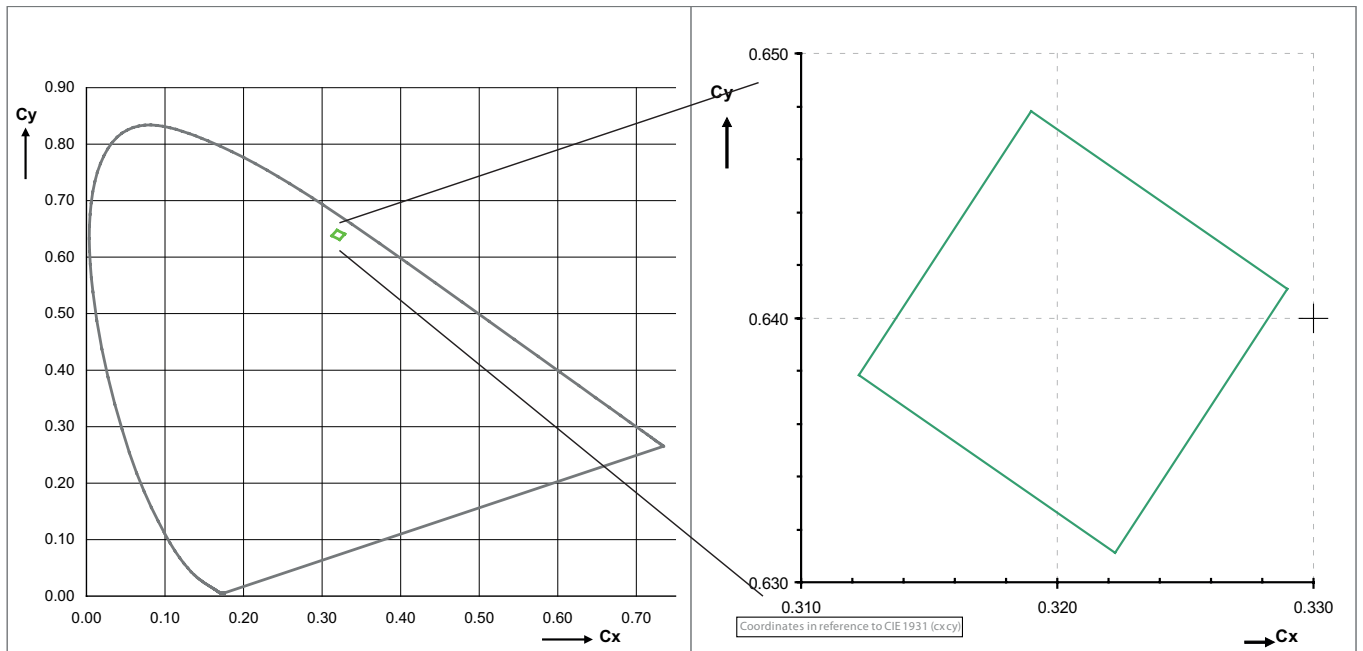

## Color Chromaticity Groups <sup>3)</sup>

Group	Cx	Cy
1	0.3123	0.6378
	0.3190	0.6478
	0.3290	0.6411
	0.3223	0.6311

## Group Name on Label

Example: LX-1

Brightness

Color Chromaticity

LX

1

### Relative Spectral Emission <sup>4)</sup>

$\Phi_{rel} = f(\lambda)$ ;  $I_F = 350 \text{ mA}$ ;  $T_J = 25 \text{ }^\circ\text{C}$

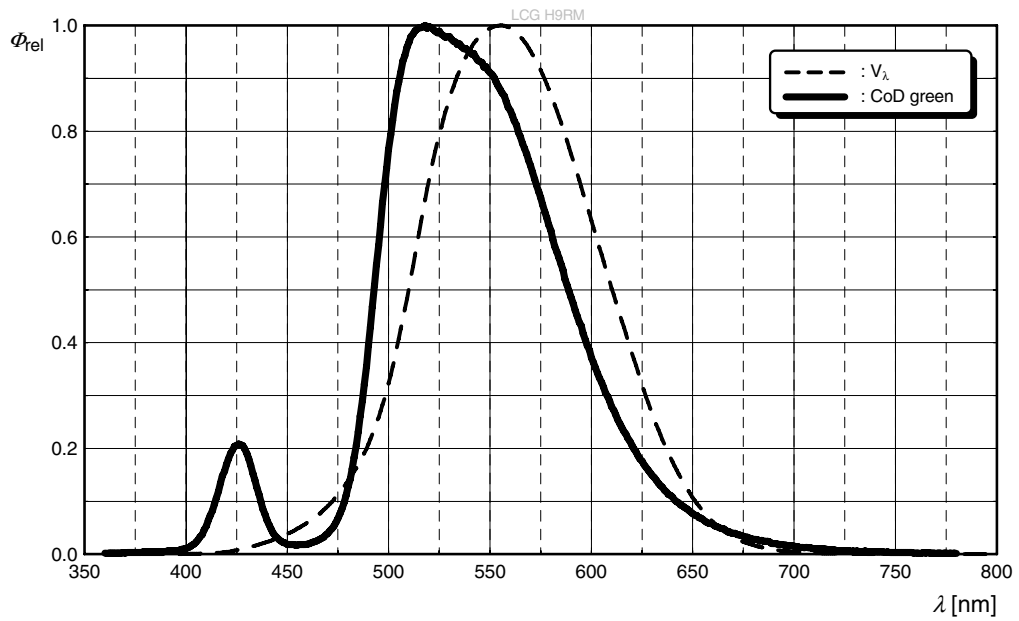

### Radiation Characteristics <sup>4)</sup>

$I_{rel} = f(\phi)$ ;  $T_J = 25 \text{ }^\circ\text{C}$

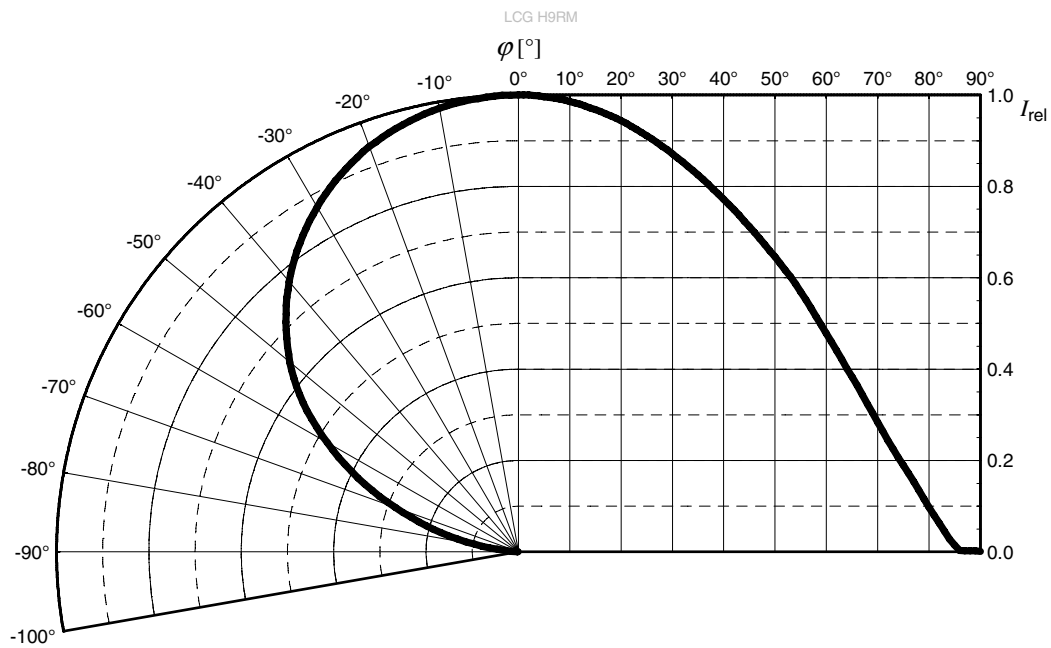

### Relative Partial Flux <sup>4)</sup>

$$\Phi_V(2\varphi)/\Phi_V(180^\circ) = f(\varphi); T_J = 25^\circ\text{C}$$

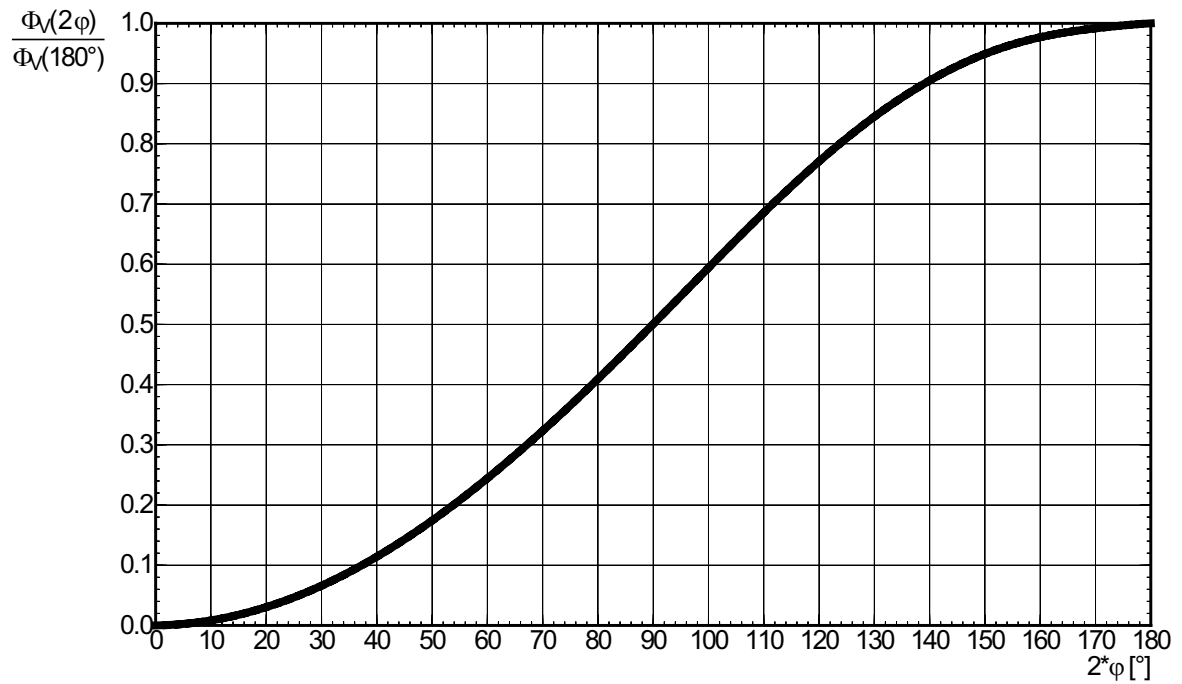

### Relative cumulated Luminous Flux <sup>4)</sup>

$$\Phi_{Vrel-cum} = f(\lambda); I_F = 350\text{ mA}; T_J = 25^\circ\text{C}$$

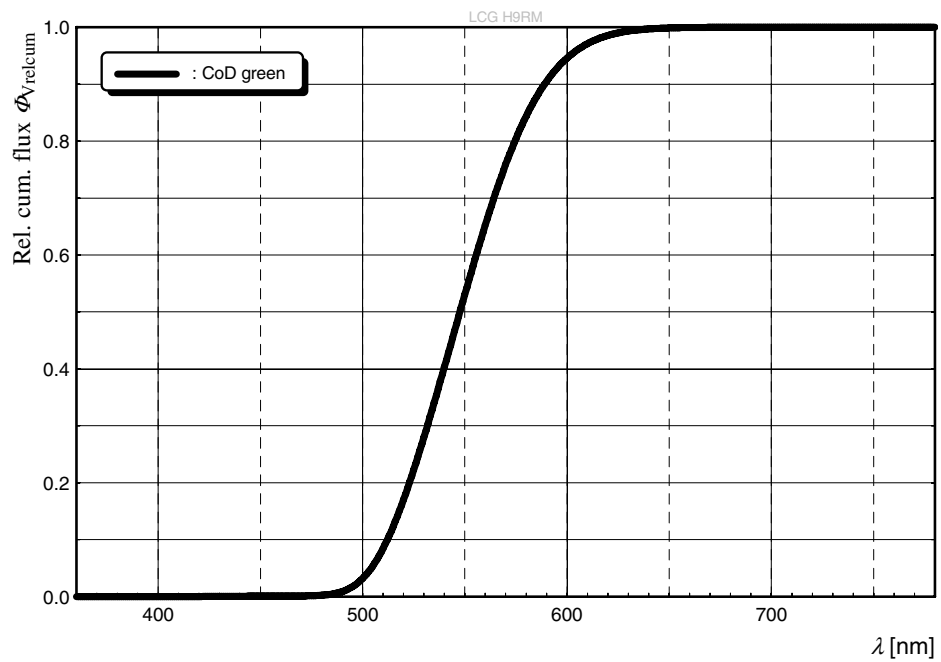

**Forward current** 4), 7)

$I_F = f(V_F); T_J = 25\text{ }^\circ\text{C}$

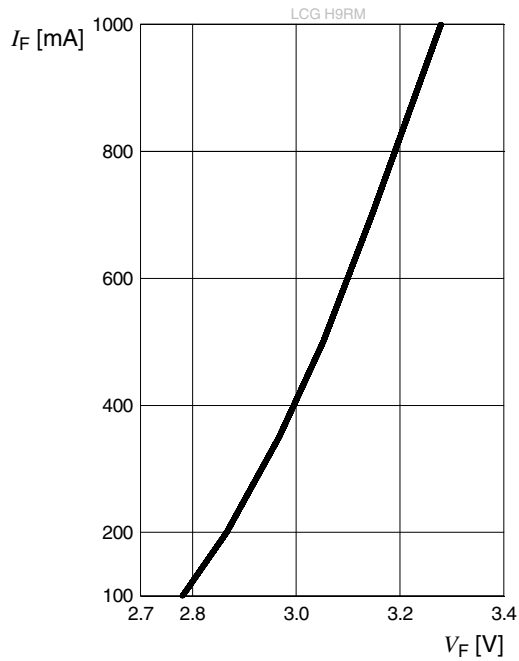

**Relative Luminous Flux** 4), 7)

$\Phi_V / \Phi_V(350\text{ mA}) = f(I_F); T_J = 25\text{ }^\circ\text{C}$

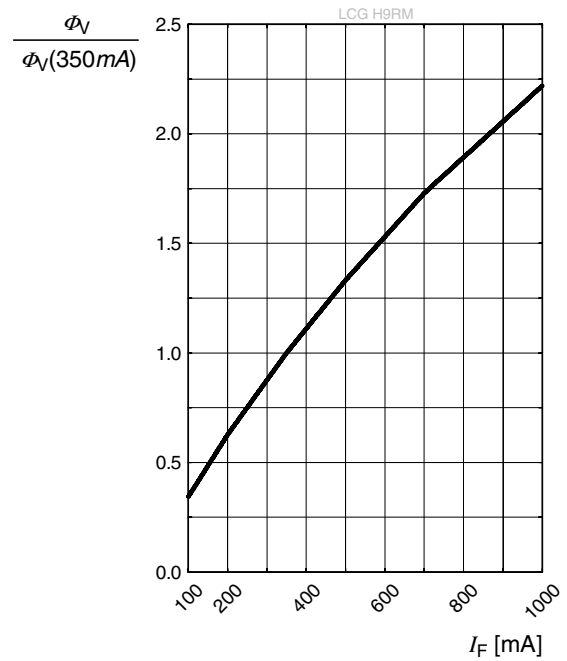

**Chromaticity Coordinate Shift** 4)

$\Delta C_x, \Delta C_y = f(I_F); T_J = 25\text{ }^\circ\text{C}; \text{ full spectral range}$

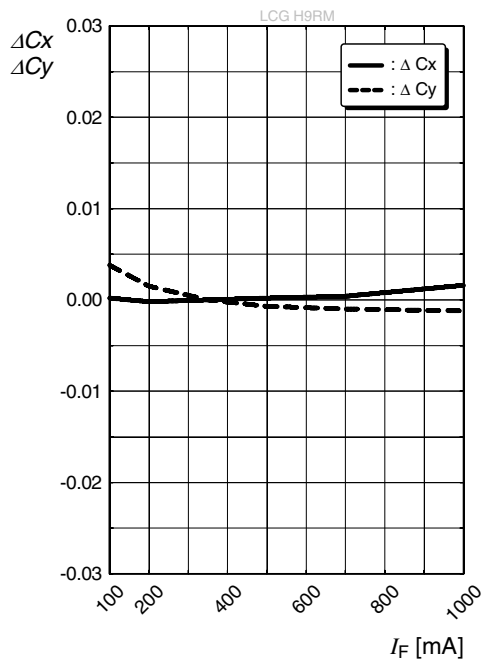

**Chromaticity Coordinate Shift** 4)

$\Delta C_x, \Delta C_y = f(I_F); T_J = 25\text{ }^\circ\text{C}; \text{ within } \lambda = 500 \dots 600\text{ nm}$

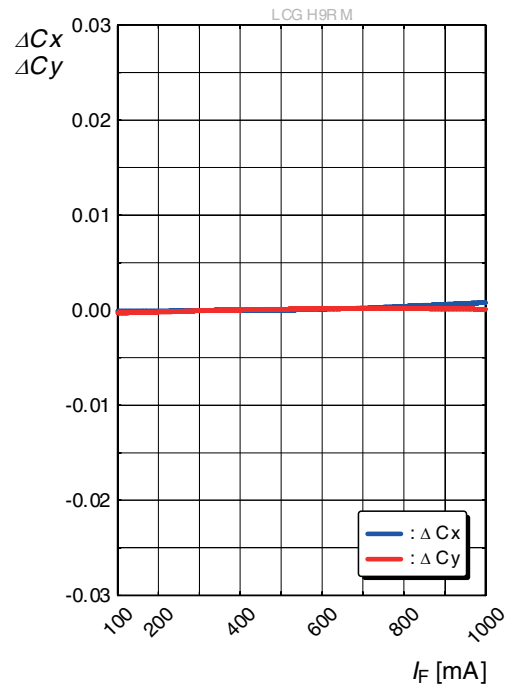

### Forward Voltage <sup>4)</sup>

$$\Delta V_F = V_F - V_F(25^\circ\text{C}) = f(T_j); I_F = 350\text{ mA}$$

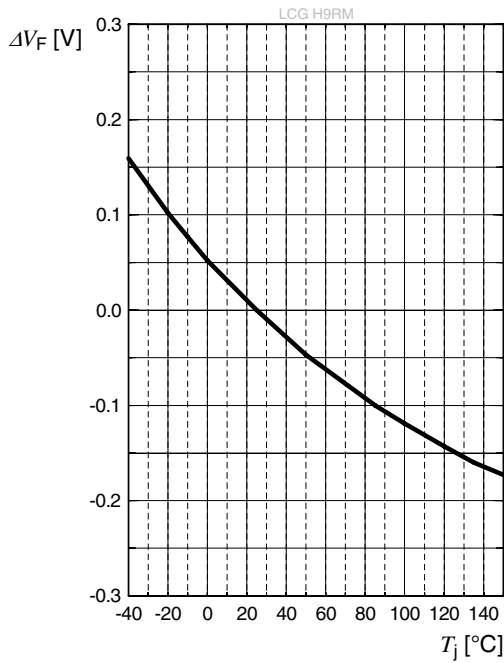

### Relative Luminous Flux <sup>4)</sup>

$$\Phi_V / \Phi_V(25^\circ\text{C}) = f(T_j); I_F = 350\text{ mA}$$

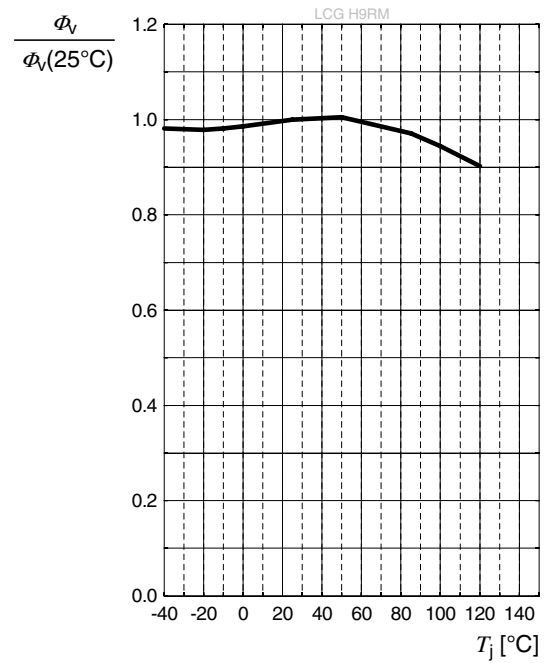

### Chromaticity Coordinate Shift <sup>4)</sup>

$$\Delta C_x, \Delta C_y = f(T_j); I_F = 350\text{ mA}; \text{full spectral range}$$

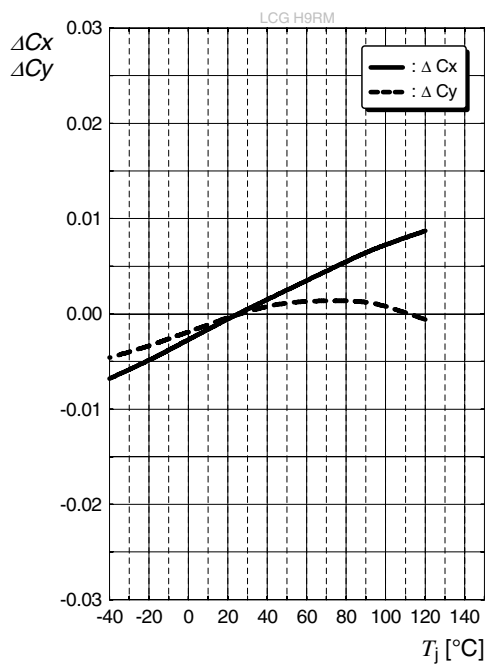

### Chromaticity Coordinate Shift <sup>4)</sup>

$$\Delta C_x, \Delta C_y = f(T_j); I_F = 350\text{ mA}; \text{within } \lambda = 500 \dots 600\text{ nm}$$

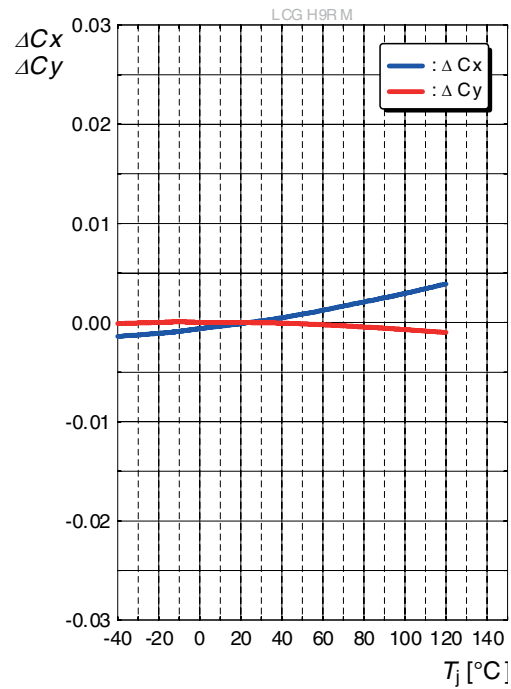



## Max. Permissible Forward Current

$$I_F = f(T)$$

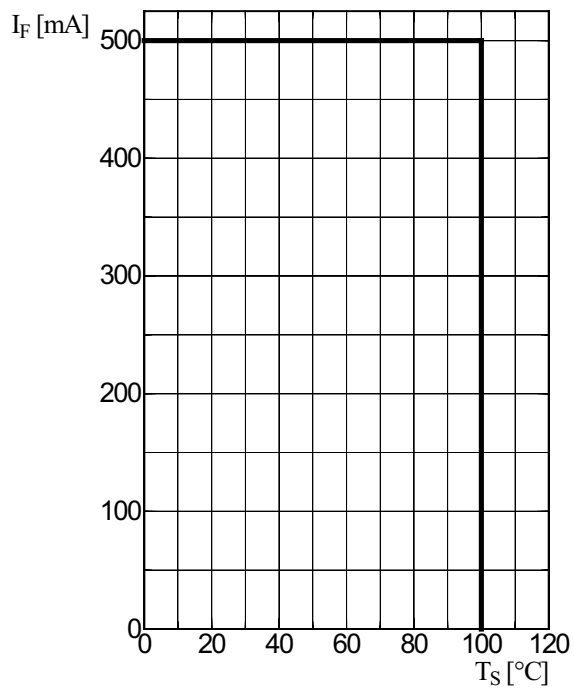

Dimensional Drawing <sup>8)</sup>

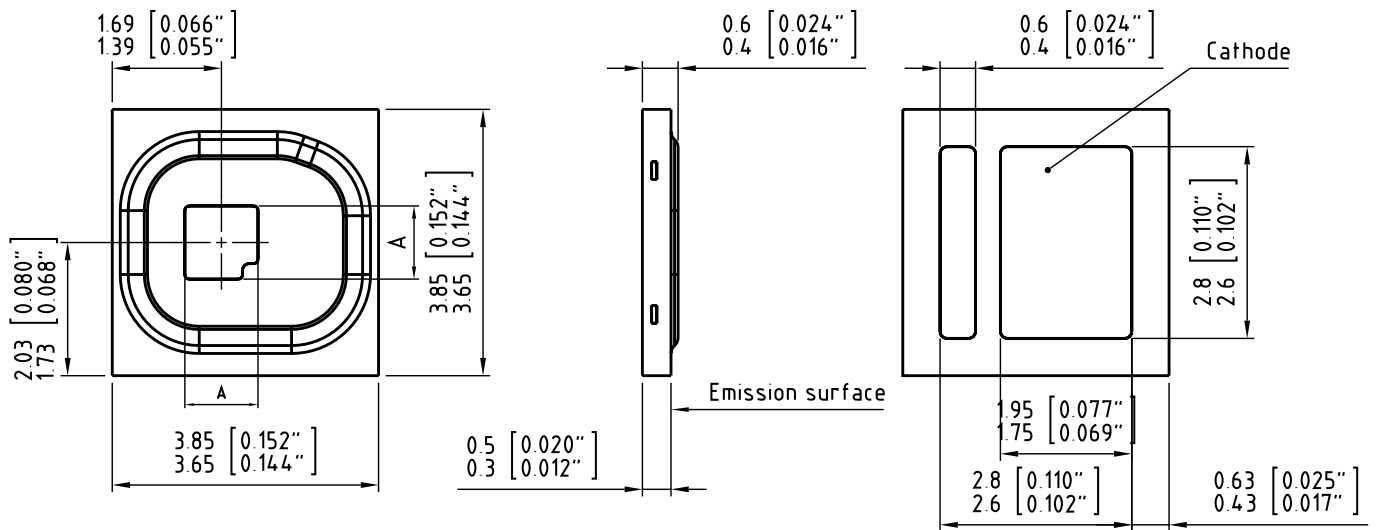

For dimension „A“ please refer to page 3

C63062-A4135-A1.-05

**Approximate Weight:** 22.0 mg

**Corrosion test:** Class: 3B  
 Test condition: 40°C / 90 % RH / 15 ppm H<sub>2</sub>S / 14 days (stricter then IEC 60068-2-43)

**ESD advice:** The device is protected by ESD device which is connected in parallel to the Chip.

## Recommended Solder Pad 8)

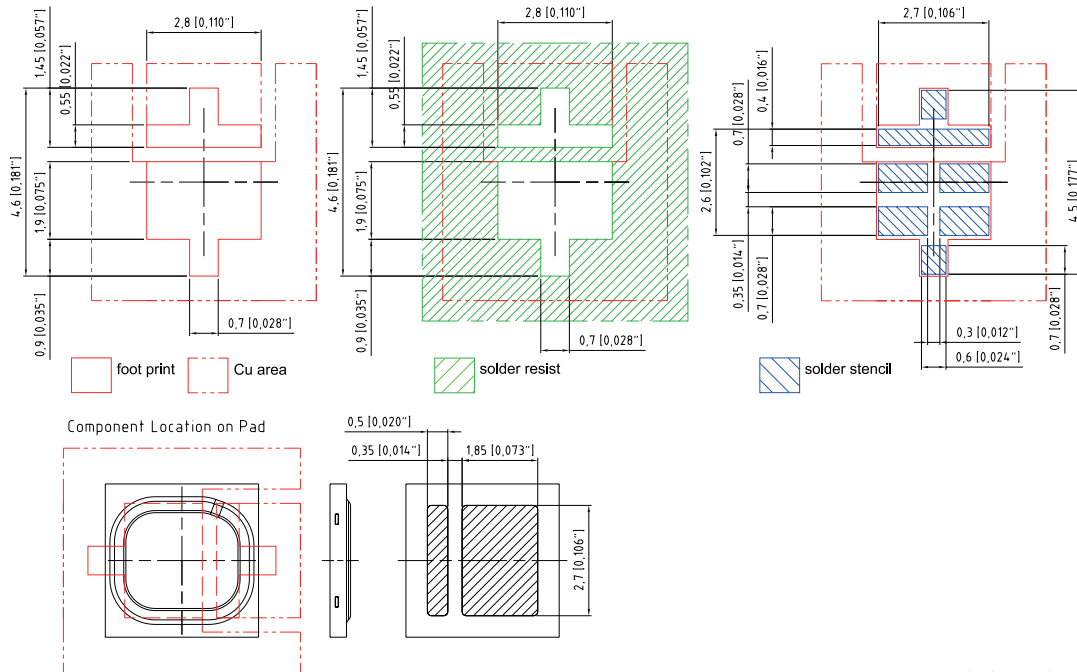

E062.3010.106 -01

For superior solder joint connectivity results we recommend soldering under standard nitrogen atmosphere. In case the PCB layout of the application is intended to be used with other OSRON derivatives or in future developed OSRON derivatives, the heat sink must not be electrically connected to anode or cathode solder pad because of possible chip inverted polarity. Package not suitable for ultra sonic cleaning.

## Reflow Soldering Profile

Product complies to MSL Level 2 acc. to JEDEC J-STD-020E

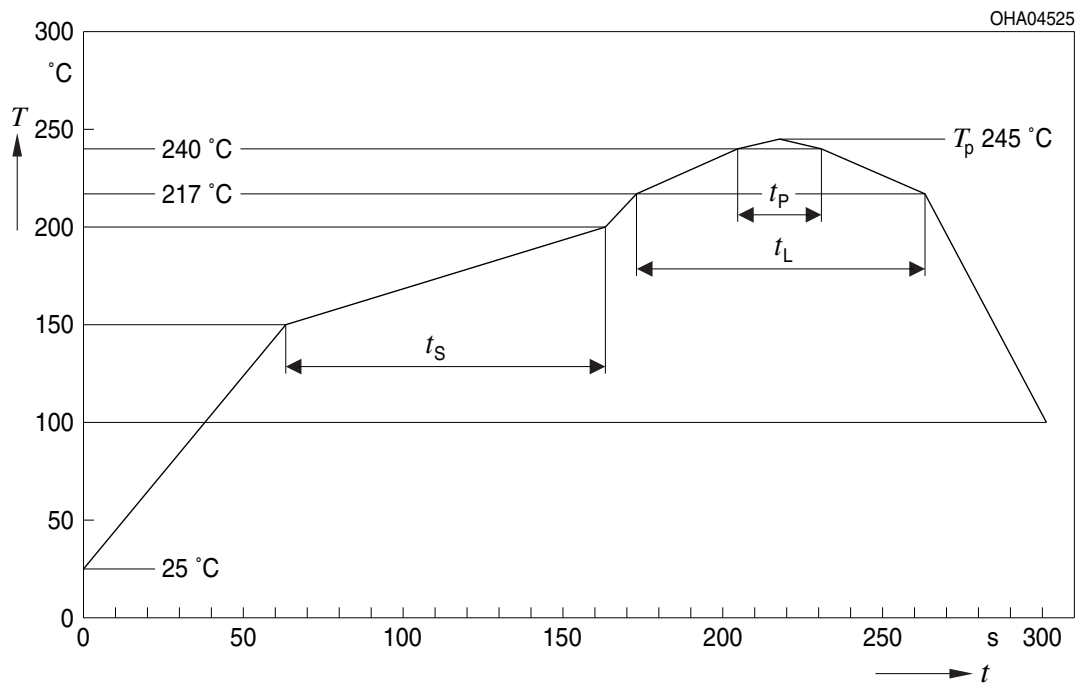

Profile Feature	Symbol	Pb-Free (SnAgCu) Assembly			Unit
		Minimum	Recommendation	Maximum	
Ramp-up rate to preheat <sup>*)</sup> 25 °C to 150 °C			2	3	K/s
Time $t_s$ $T_{Smin}$ to $T_{Smax}$	$t_s$	60	100	120	s
Ramp-up rate to peak <sup>*)</sup> $T_{Smax}$ to $T_p$			2	3	K/s
Liquidus temperature	$T_L$		217		°C
Time above liquidus temperature	$t_L$		80	100	s
Peak temperature	$T_p$		245	260	°C
Time within 5 °C of the specified peak temperature $T_p - 5$ K	$t_p$	10	20	30	s
Ramp-down rate* $T_p$ to 100 °C			3	6	K/s
Time 25 °C to $T_p$				480	s

All temperatures refer to the center of the package, measured on the top of the component

\* slope calculation  $DT/Dt$ :  $Dt$  max. 5 s; fulfillment for the whole T-range

Taping <sup>8)</sup>

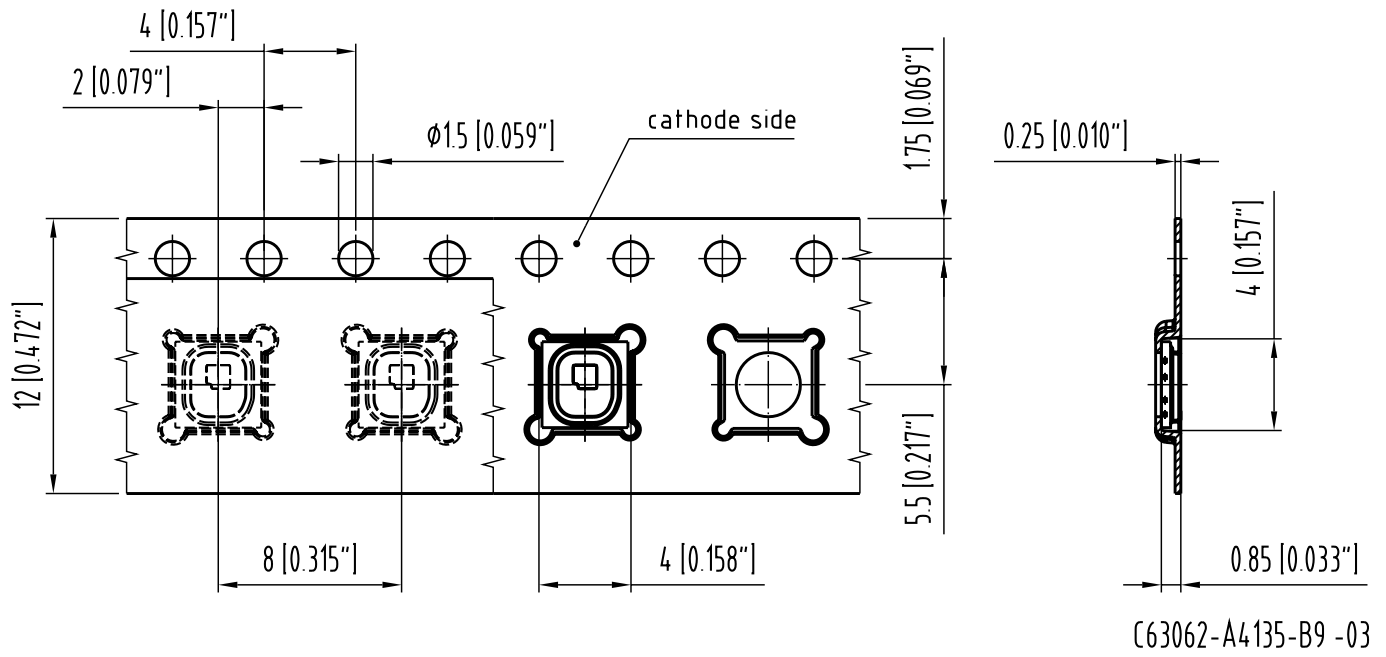

**Tape and Reel** <sup>9)</sup>

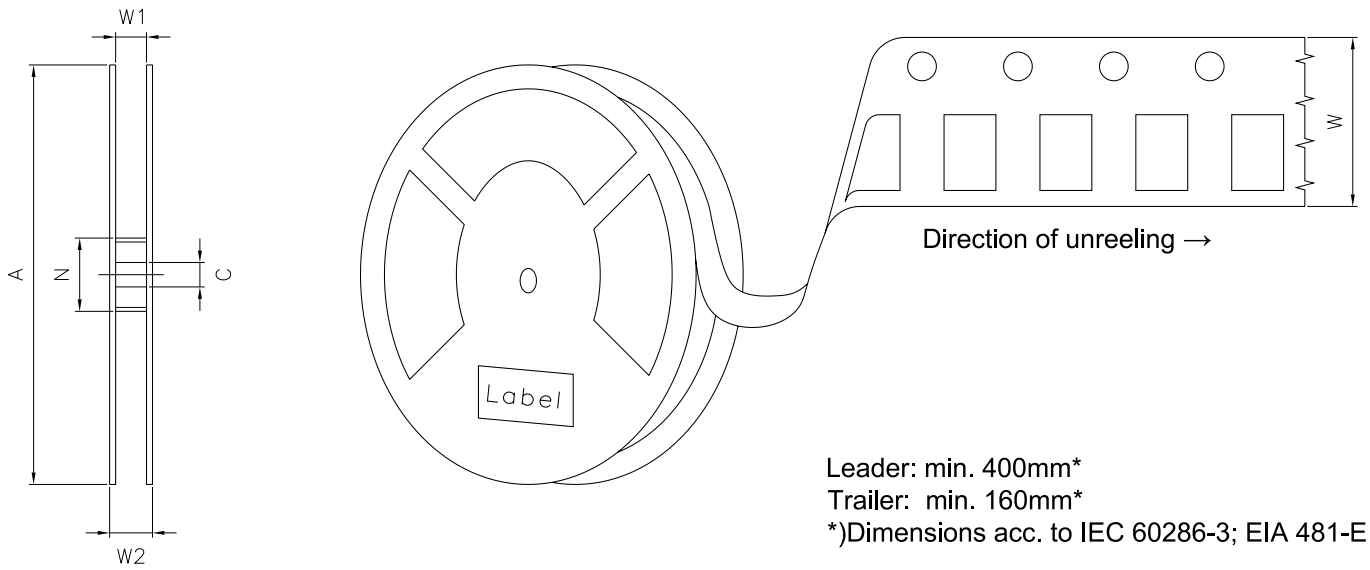

**Reel dimensions [mm]**

A	W	N <sub>min</sub>	W <sub>1</sub>	W <sub>2max</sub>	Pieces per PU
180 mm	12 + 0.3 / - 0.1	60	12.4 + 2	18.4	2000

### Barcode-Product-Label (BPL)

**OSRAM Opto Semiconductors** LX XXXX BIN1: XX-XX-X-XXX-X

RoHS Compliant

(6P) BATCH NO: 1234567890

(1T) LOT NO: 1234567890 (9D) D/C: 1234

(X) PROD NO: 123456789 (Q) QTY: 9999 (G) GROUP: XX-XX-X-X

ML Temp ST  
X XXX °C X

Pack: RXX  
DEMY XXX  
X\_X123\_1234.1234 X



The diagram shows a rectangular label with rounded corners. It contains the OSRAM logo and product name at the top left. To the right are fields for 'LX XXXX' and 'BIN1: XX-XX-X-XXX-X'. Below the logo is a 'RoHS Compliant' statement. The label features three horizontal barcode sections. The first is labeled '(6P) BATCH NO: 1234567890'. The second is labeled '(1T) LOT NO: 1234567890' and '(9D) D/C: 1234'. The third is labeled '(X) PROD NO: 123456789 (Q) QTY: 9999 (G) GROUP: XX-XX-X-X'. To the right of the second barcode is a 'No Moisture' symbol (a circle with a diagonal line and three droplets) and the text 'ML Temp ST X XXX °C X'. Below this is a square QR code. Further down are the fields 'Pack: RXX', 'DEMY XXX', and 'X\_X123\_1234.1234 X'. A large 'EXAMPLE' watermark is overlaid diagonally across the center of the label.

OHA04563

### Dry Packing Process and Materials <sup>8)</sup>

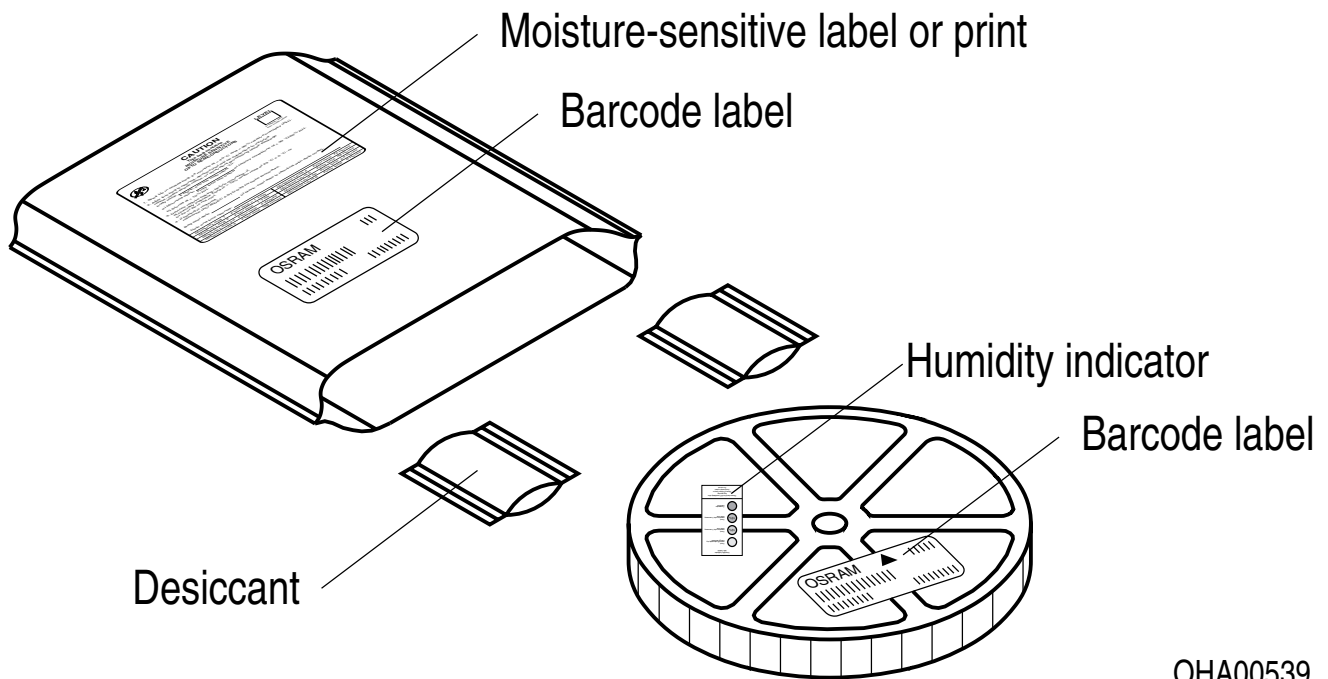

OHA00539

Moisture-sensitive product is packed in a dry bag containing desiccant and a humidity card according JEDEC-STD-033.

**Transportation Packing and Materials** <sup>8)</sup>

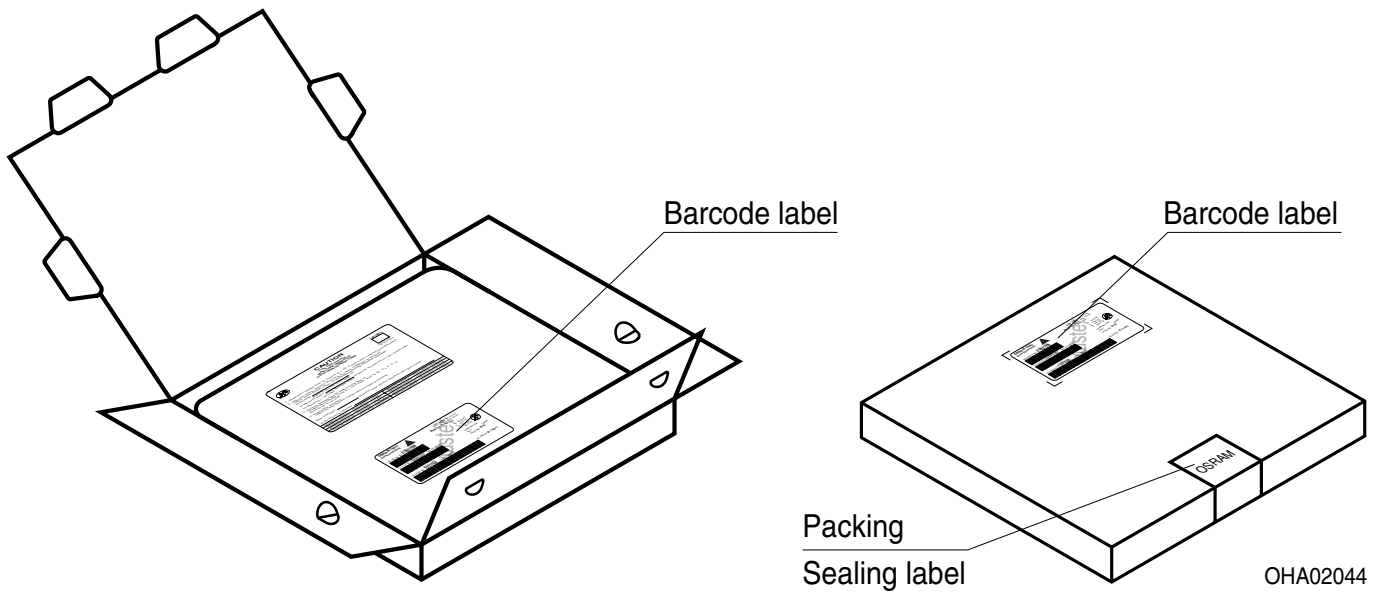

**Dimensions of transportation box in mm**

Width	Length	Height
195 ± 5 mm	195 ± 5 mm	30 ± 5 mm



## Type Designation System

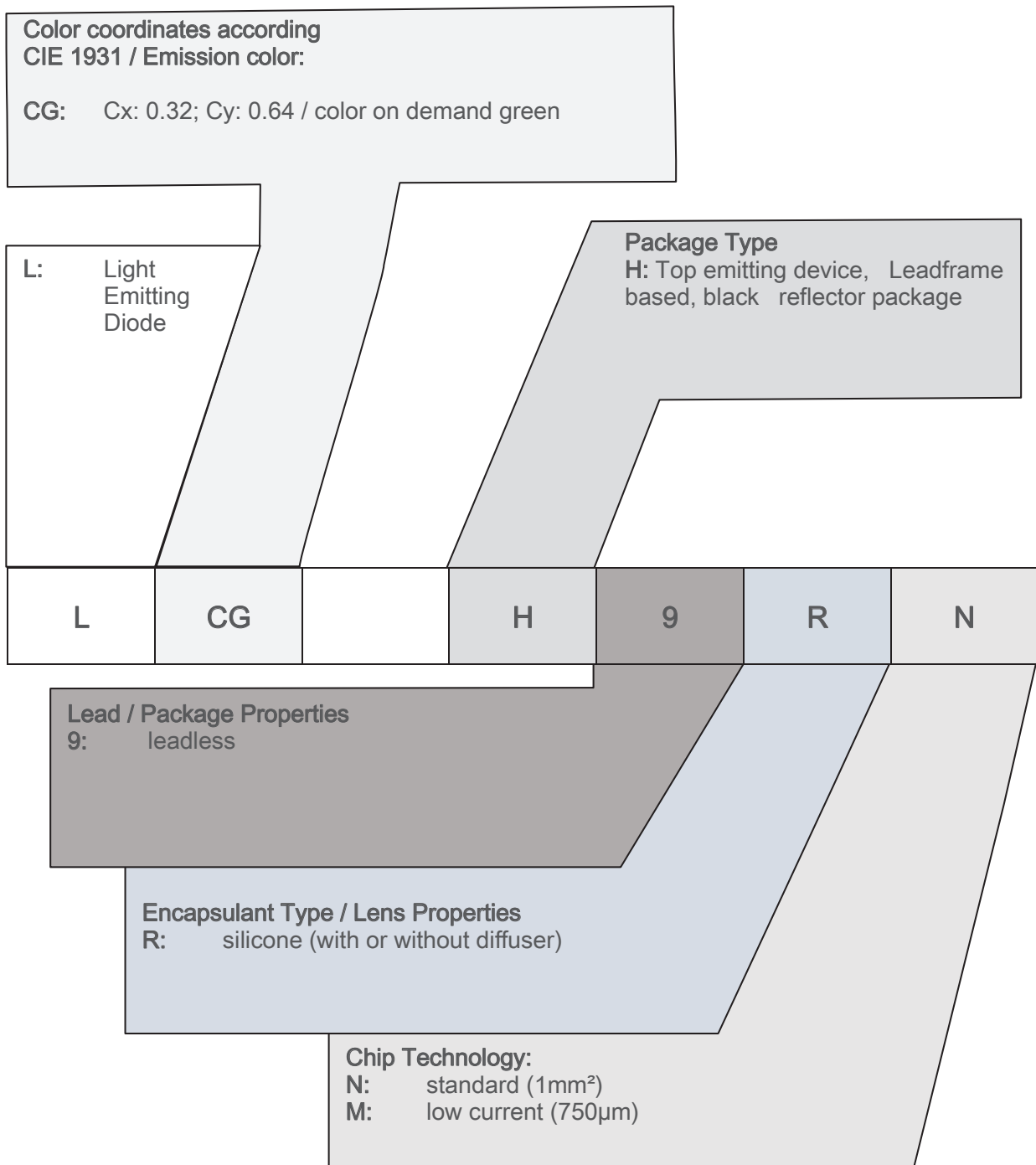

## Notes

The evaluation of eye safety occurs according to the standard IEC 62471:2006 (photo biological safety of lamps and lamp systems). Within the risk grouping system of this IEC standard, the device specified in this data sheet falls into the class **low risk (exposure time 100 s)**. Under real circumstances (for exposure time, conditions of the eye pupils, observation distance), it is assumed that no endangerment to the eye exists from these devices. As a matter of principle, however, it should be mentioned that intense light sources have a high secondary exposure potential due to their blinding effect. When looking at bright light sources (e.g. headlights), temporary reduction in visual acuity and afterimages can occur, leading to irritation, annoyance, visual impairment, and even accidents, depending on the situation.

Subcomponents of this device contain, in addition to other substances, metal filled materials including silver. Metal filled materials can be affected by environments that contain traces of aggressive substances. Therefore, we recommend that customers minimize device exposure to aggressive substances during storage, production, and use. Devices that showed visible discoloration when tested using the described tests above did show no performance deviations within failure limits during the stated test duration. Respective failure limits are described in the IEC60810.

For further application related informations please visit [www.osram-os.com/appnotes](http://www.osram-os.com/appnotes)

## Disclaimer

### Disclaimer

Language english will prevail in case of any discrepancies or deviations between the two language wordings.

### Attention please!

The information describes the type of component and shall not be considered as assured characteristics. Terms of delivery and rights to change design reserved. Due to technical requirements components may contain dangerous substances.

For information on the types in question please contact our Sales Organization.

If printed or downloaded, please find the latest version on the OSRAM OS website.

### Packing

Please use the recycling operators known to you. We can also help you – get in touch with your nearest sales office.

By agreement we will take packing material back, if it is sorted. You must bear the costs of transport. For packing material that is returned to us unsorted or which we are not obliged to accept, we shall have to invoice you for any costs incurred.

### Product safety devices/applications or medical devices/applications

OSRAM OS components are not developed, constructed or tested for the application as safety relevant component or for the application in medical devices.

In case Buyer – or Customer supplied by Buyer– considers using OSRAM OS components in product safety devices/applications or medical devices/applications, Buyer and/or Customer has to inform the local sales partner of OSRAM OS immediately and OSRAM OS and Buyer and /or Customer will analyze and coordinate the customer-specific request between OSRAM OS and Buyer and/or Customer.

---

## Glossary

- 1) **Brightness:** Brightness values are measured during a current pulse of typically 25 ms, with an internal reproducibility of  $\pm 8\%$  and an expanded uncertainty of  $\pm 11\%$  (acc. to GUM with a coverage factor of  $k = 3$ ).
- 2) **Reverse Operation:** Reverse Operation of 10 hours is permissible in total. Continuous reverse operation is not allowed.
- 3) **Chromaticity coordinate groups:** Chromaticity coordinates are measured during a current pulse of typically 25 ms, with an internal reproducibility of  $\pm 0.005$  and an expanded uncertainty of  $\pm 0.01$  (acc. to GUM with a coverage factor of  $k = 3$ ).
- 4) **Typical Values:** Due to the special conditions of the manufacturing processes of semiconductor devices, the typical data or calculated correlations of technical parameters can only reflect statistical figures. These do not necessarily correspond to the actual parameters of each single product, which could differ from the typical data and calculated correlations or the typical characteristic line. If requested, e.g. because of technical improvements, these typ. data will be changed without any further notice.
- 5) **Forward Voltage:** The forward voltage is measured during a current pulse of typically 8 ms, with an internal reproducibility of  $\pm 0.05\text{ V}$  and an expanded uncertainty of  $\pm 0.1\text{ V}$  (acc. to GUM with a coverage factor of  $k = 3$ ).
- 6) **Thermal Resistance:**  $R_{th\ max}$  is based on statistic values ( $6\sigma$ ).
- 7) **Characteristic curve:** In the range where the line of the graph is broken, you must expect higher differences between single devices within one packing unit.
- 8) **Tolerance of Measure:** Unless otherwise noted in drawing, tolerances are specified with  $\pm 0.1$  and dimensions are specified in mm.
- 9) **Tape and Reel:** All dimensions and tolerances are specified acc. IEC 60286-3 and specified in mm.

Published by OSRAM Opto Semiconductors GmbH EU RoHS and China RoHS compliant product  
Leibnizstraße 4, D-93055 Regensburg  
www.osram-os.com © All Rights Reserved.



此产品符合欧盟 RoHS 指令的要求；  
按照中国的相关法规和标准，不含有毒有害物质或元素。